

Seating Checklist

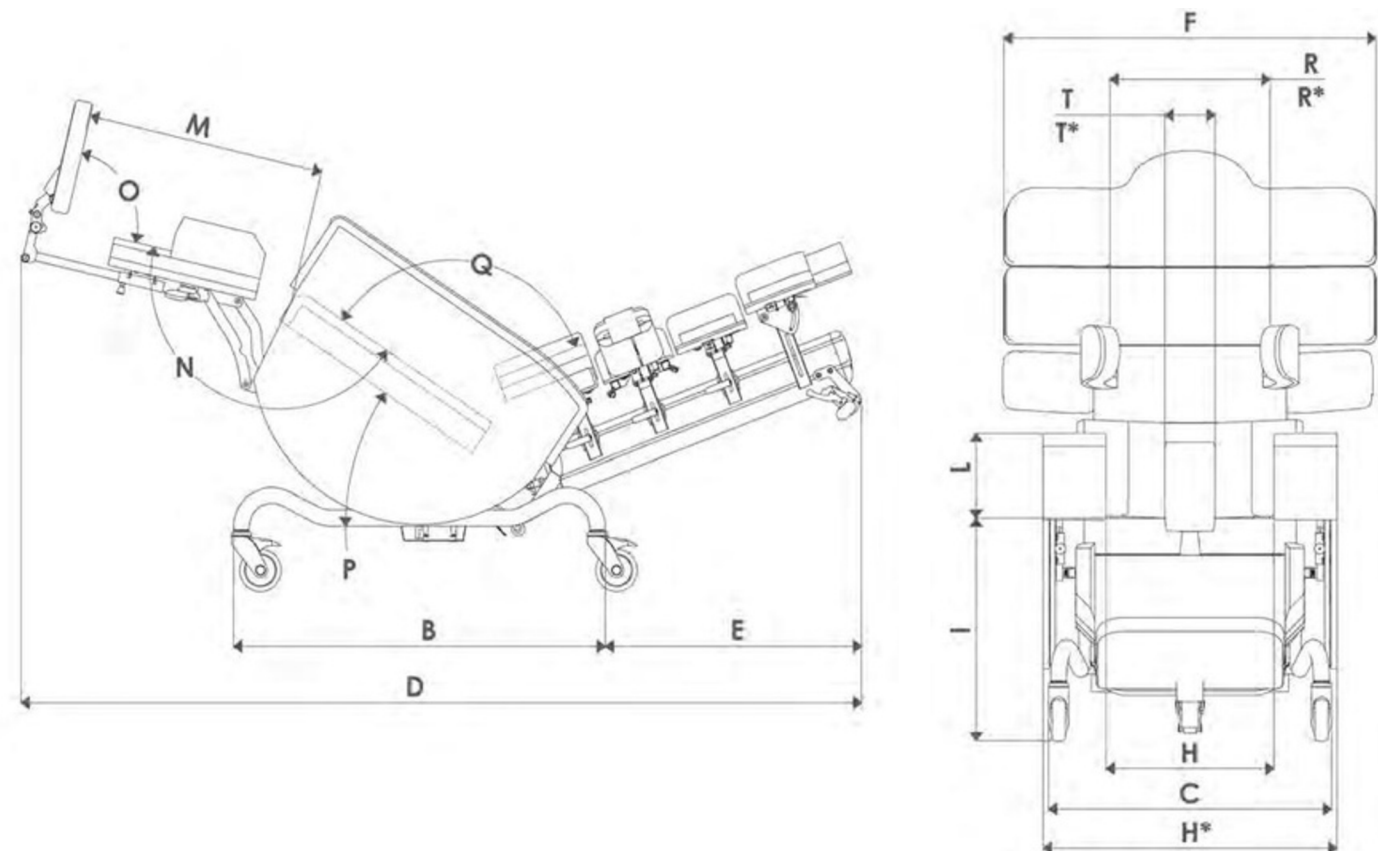





FUNCTION	ADJUSTMENT RANGE	MEASUREMENT / ANGLE / SELECTION
R/R*: Lateral Support Width (Optional)	Narrow: (S) 140mm - 340mm (M) 200mm - 400mm (200mm range) Wide: (S) 240mm - 440mm (M) 300mm - 500mm (200mm range) Small Chair (S): 230mm - 470mm (240mm range)	
R**: Lateral Support Height from Seat (If applicable)	Medium Chair (M): 250mm - 500mm (250mm range) Small Pad: 160mm	
R***: Lateral Pad Depth (See technical data for drawing)	Medium Pad: 190mm	
Q: Back Angle Recline (BAR)	90° - 125°	
P: Tilt-in-Space (TiS)	Small Chair: 0° - -30° Medium Chair: 0° - -35°	
N: Leg Rest Angle	Small Chair: 75° - 165° Medium Chair: 70° - 160°	
O: Footplate Angle	-75° / 90° / 105° / 120°	
Adjustment Control Option	Manual / Pro-Control (Leg Rest & Tilt-in-Space Only) / Fully Motorised	



Optional Accessories

NAME	DESCRIPTION	IMAGE	SELECTION
Back Quick Release Adjustment Kit	<ul style="list-style-type: none"> Quick release to back elements for ease of adjustments without tools. Suitable for multi-user environments. 		<input type="checkbox"/>
Back Lever Adjustment Kit	<ul style="list-style-type: none"> Adjustment levers to back elements for ease of adjustments without tools. Suitable for multi-user environments or changing user needs. 		<input type="checkbox"/>
Pommel	<ul style="list-style-type: none"> A fully padded pommel. Provides both lateral and swivel tool-free adjustments to support deformities such as windsweeping. 		<input type="checkbox"/>
Lateral Supports	<ul style="list-style-type: none"> External and removable trunk control with independent height and width adjustment. May be indicated for individuals who require firmer postural support to achieve an optimum midline position. 		<input type="checkbox"/> <input type="checkbox"/> Narrow Wide <input type="checkbox"/> S = Small Pad <input type="checkbox"/> M = Medium Pad
Kidney Shaped Lateral Supports	<ul style="list-style-type: none"> Adaptable trunk control with independent height and width adjustment. Shaped for comfort and effective support to midline. 		<input type="checkbox"/>
Soft Headrest	<ul style="list-style-type: none"> A comfortable rectangular pillow that can support the head if an individual presents with weakness or fatigue. Available in shallow and deep. 		<input type="checkbox"/> <input type="checkbox"/> Shallow Deep
Soft Profiled Headrest	<ul style="list-style-type: none"> A contoured pillow to support shoulders, neck and head. Encourages head alignment for interaction and optimum physiological function. Available in shallow and deep. 		<input type="checkbox"/> <input type="checkbox"/> Shallow Deep
In-line Headrest	<ul style="list-style-type: none"> Memory Foam lining providing full cranial support with cut-away sides for unobstructed sight and hearing. 		<input type="checkbox"/>
Foam Headrest	<ul style="list-style-type: none"> Available in shallow, medium and deep, providing basic lateral head control. 		<input type="checkbox"/> <input type="checkbox"/> <input type="checkbox"/> Shallow Med. Deep
Neck Headrest	<ul style="list-style-type: none"> Has a deep profile to give greater lateral control. 		<input type="checkbox"/>
Tray	<ul style="list-style-type: none"> A plastic tray with low profiled edges. Supports the upper limbs and offers a platform for engagement in activities or occupation. 		<input type="checkbox"/>
Detachable Footplate Pad	<ul style="list-style-type: none"> To provide greater comfort or for shorter leg length. Medium chair only. 		<input type="checkbox"/>
Footplate Lozenge	<ul style="list-style-type: none"> To provide greater comfort or for shorter leg length. Medium chair only. 		<input type="checkbox"/>

Optional Accessories

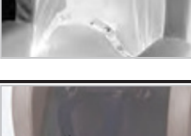
NAME	DESCRIPTION	IMAGE	SELECTION
Soft Pillow Footplate Pad	<ul style="list-style-type: none"> A soft pillow that can be easily fixed to the footplate to provide greater comfort and support for individuals with fixed foot deformities. Medium chair only. 		<input type="checkbox"/> Shallow <input type="checkbox"/> Deep
Channel Footplate Pad	<ul style="list-style-type: none"> Easily fixed to the footplate to provide greater comfort whilst encouraging a midline position at the feet. Medium chair only. 		<input type="checkbox"/>
Basic Pelvic Belt	<ul style="list-style-type: none"> A simple webbing belt ideal for use during portering. 		<input type="checkbox"/>
Padded Pelvic Belt*	<ul style="list-style-type: none"> Intervention for anterior pelvic stabilisation. Safety belt when portering. 		<input type="checkbox"/>
4-Point Padded Pelvic Belt*	<ul style="list-style-type: none"> Centre pull adjustment and comfort pads to reduce pressure on the front of the pelvis. Secondary straps that pull down over the thighs at right angles to the seat base to maximise pelvic stability and reduce the risk of sacral sitting. 		<input type="checkbox"/>
Groin Harness*	<ul style="list-style-type: none"> Positioning aid that provides maximum pelvic control. Prevents the user from sliding forward in the seat. 		<input type="checkbox"/>
Dynamic Chest Harness*	<ul style="list-style-type: none"> Provides anterior support and comfort whilst not restricting active positioning and function. Lower straps have multi-direction buckles that swivel to avoid twisting and provide comfort. 		<input type="checkbox"/>
Sternum Harness*	<ul style="list-style-type: none"> Provides greater upper trunk stability but allows for user movement. 		<input type="checkbox"/>

*All belts and harnesses (positioning aids) must be prescribed, implemented, and monitored responsibly following a comprehensive risk assessment. Please see the following for further information:

- Medicines and Healthcare Regulatory Agency (MHRA) (2015) MDA/2015/018 *All posture or safety belts fitted to supportive seating, wheelchairs, hoists and bathroom equipment* London: MHRA
- British Standard (BS) (2019) 8625:2019 *Selection, placement and fixation of flexible postural support devices in seating* London: BSI

Optional Accessories

Back Depth Adjustment Brackets - Options

NAME	DESCRIPTION	IMAGE	SELECTION
Back Depth Adjustment Bracket Upgrade	<ul style="list-style-type: none"> Upper back – 100mm Std Adjustment (Upgrade to 150mm / 200mm / 250mm / 300mm) Upper-middle back - 40mm Std Adjustment (Upgrade to 150mm / 200mm / 250mm / 300mm) Lower-middle back – 40mm Std Adjustment (Upgrade to 150mm / 200mm / 250mm / 300mm) Lower back - 40mm Std Adjustment (Upgrade to 150mm / 200mm / 250mm / 300mm) 		<input type="checkbox"/> Upper Back
			<input type="checkbox"/> Upper Middle Back
			<input type="checkbox"/> Lower Middle Back
			<input type="checkbox"/> Lower Back

